

COMPUTER BEAM GUN

PROFESSIONAL

DIRECTIONS

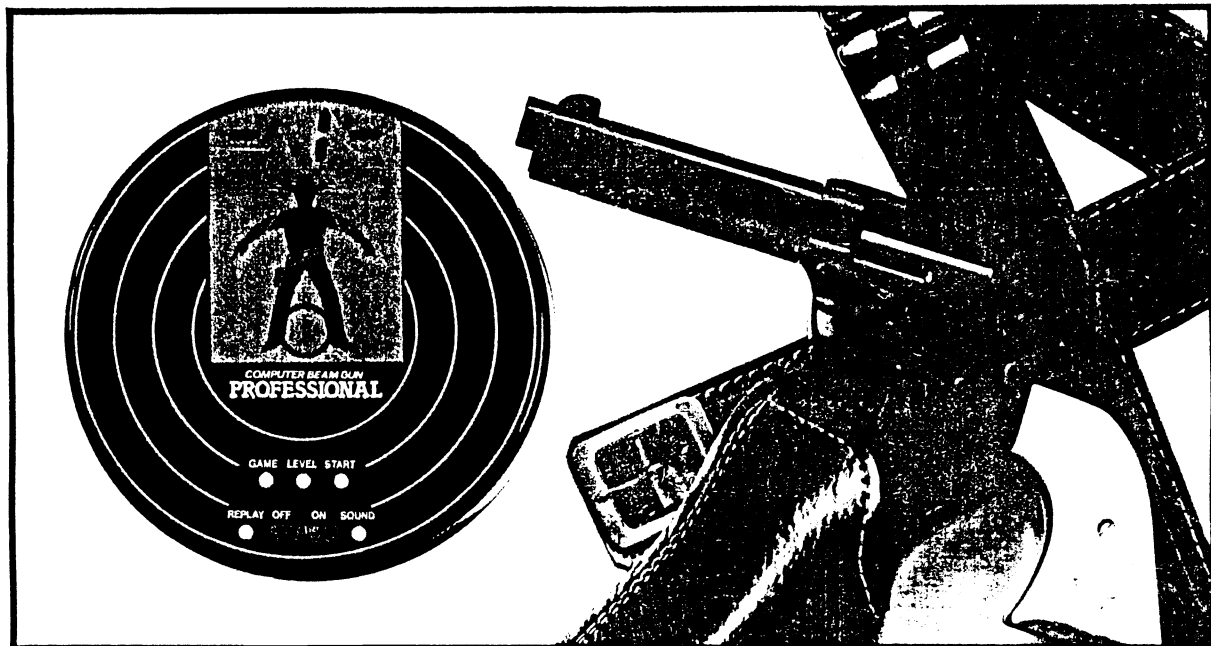

The computer target game that shoots back!

- ★ Three different games
- ★ Five skill levels
- ★ With buckle-on holster

Buckle on your holster for this computer target game that shoots back.

There are three different game patterns to play-Fast Draw, Showdown and Tombstone Alley. And, if you're a real pro, play at the toughest skill level.

There are 5 levels to choose from.

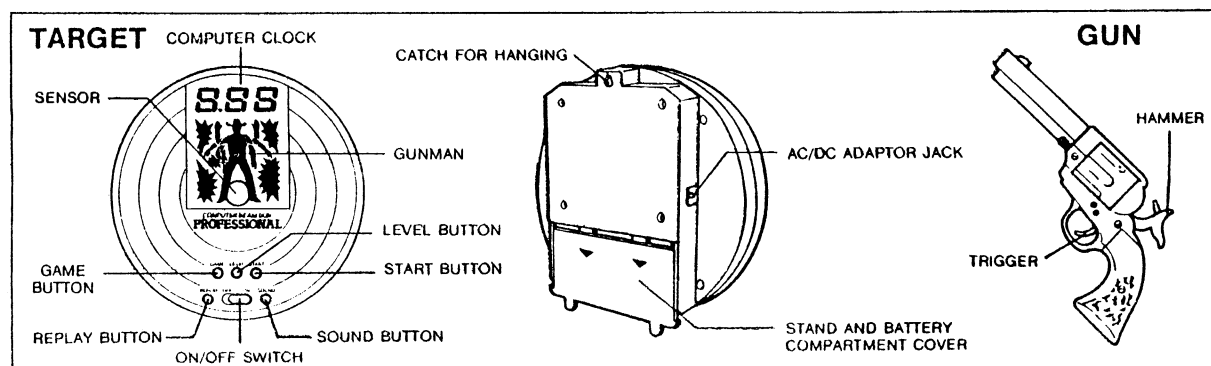

TARGET OPERATION BUTTONS AND DISPLAY

ON/OFF SWITCH

To activate the target, set the On/Off Switch to the "ON" position. The target display will light up. When you are finished playing, be sure to set the switch back to the "OFF" position.

LEVEL SELECT BUTTON

This button is used to select the desired skill level. There are five levels, each requiring a progressively faster "draw and fire" of your gun.

The skill levels are:

Level 500— This is the easiest level. You have 5 seconds to draw and fire.

Level 400, **Level 300**, **Level 200**

Level 100— This is the toughest level. You have 1 second to draw and fire.

When the target is switched on, it is automatically set to level 500. To set a different level, press the Level Select Button until the desired level appears at the top of the target display.

GAME BUTTON

This button is used to select the desired game pattern.

There are three different game patterns:

- Game 1 Fast Draw
- Game 2 Showdown
- Game 3 Tombstone Alley

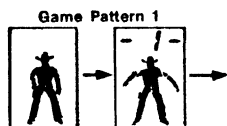

When the target is switched on, it is automatically set to game 1.

To select a different game pattern, press the Game Button until the number of the desired game pattern appears at the top of the target display.

SOUND BUTTON

This button is used to select desired sound effects or absence of sound effects. There are three sound mode choices:

S-1 Complete electronic sound effects including a beep to signal start of the computer clock.

S-2 No beep to signal start of the computer clock, but all other electronic sound effects.

S-3 No electronic sound effects at all.

When the target is switched on, it is automatically set to "S-1". To change to "S-2" or "S-3", press the Sound Button until the desired sound mode appears at the top of the target display.

REPLAY BUTTON

This button is used to select one of two possible modes:

LLL You may change to a new game pattern and/or level at the end of a game. Select the new game pattern and/or level by pressing the required buttons.

Then press the Start Button.

If you do not select a new game pattern and/or level, the same game will start again after approximately 15 seconds.

SSS You can play the same game again immediately after the end of a game.

The same game pattern will automatically reappear. You cannot change the game pattern and/or level.

When the target is switched on, it is automatically set to "LLL". To change to "SSS", press the Replay Button. You will see "SSS" at the top of the target display.

START BUTTON

This button is used to start a game.

BATTERIES

The target operates on 4 "C" batteries. To insert the batteries, slide the battery compartment cover back in the direction of the arrows. Be sure that the (+) and (-) ends of the batteries are properly aligned.

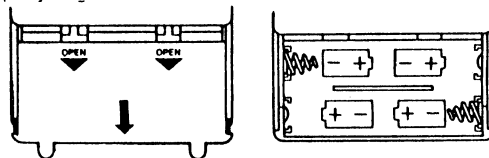

If you wish, you may use an AC/DC adaptor for greater economy.

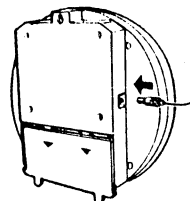

Note: Power requirement for A/C-D/C adaptor 6-Volts DC, 250 - 300 mA



The gun operates on 2 "AAA" batteries. Remove the screw on the right side of the gun grip and insert the batteries.

Be sure that the (+) and (-) ends are properly aligned.

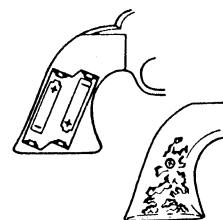

Note: The target and gun will not function properly if their batteries are weak. If they malfunction or if the display is erratic, replace the batteries.

If the game is not in use for long periods of time, remove the batteries.

You can shoot the gun in rapid succession, but this will quickly wear down the gun batteries.

TO SET UP THE TARGET

On the Wall

Using the catch, hang the target on the wall at chest height.

On a Level Surface

Slide the battery compartment cover down one step and place the target on a table or other level surface. The target should be set at chest height.

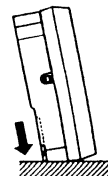
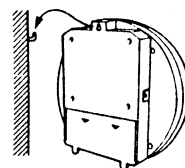

TO PLAY

1. Put on the holster and insert the gun. Hang up or set up the target.
2. Set the target's On/Off Switch to the "ON" position.
3. Select the desired game pattern, level and sound mode. Select Replay ("SSS") if desired.
4. Press the Start Button. You will see the selected game pattern number and the skill level alternately at the top of the display.
5. Step back 6 or more feet from the target.

- The computer clock will start when the gunman places his hand on his gun. In sound mode "S-1", you will hear a beep.
- At the start of the clock, draw your gun and cock the hammer. Take aim at the sensor in the center of the target. Fire by pulling the trigger. You must shoot the gunman by hitting the sensor of the target with the beam of your gun before the selected time runs out.
- If you shoot the gunman before the clock runs out, the clock count will stop immediately. You will see your shooting time on the display.
- If you do not shoot the gunman within the selected time, the clock will run out and the gunman will shoot you.
- At the end of a game, the results of the game will be displayed.

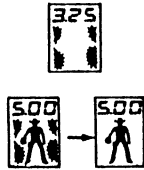

GAME - 2 - Display (Skill Level "400")

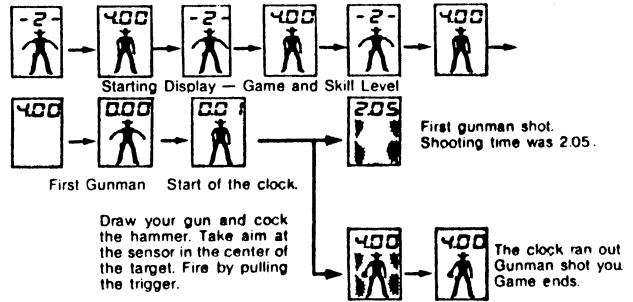

GAME - 3 - TOMBSTONE ALLEY

In this game, you are faced randomly by two different kinds of gunmen — one who is preparing to fire, one who is surrendering.



Gunman who is preparing to shoot.



Gunman who is surrendering.

The game ends after you have faced five of the gunmen who are preparing to fire.

You must not shoot a gunman who is surrendering.

You will score no points but the game will continue.

If you do shoot a gunman who is surrendering, the game ends and you will see "---" on the display.

Each time you shoot a gunman who is preparing to shoot you, you will score from 1 to 20 points.

The number of points scored depends on how quickly you shoot the gunman. If you are shot by a gunman, you score no points but the game will continue.

At the end of the game you will see the results of the game on the target display — your fastest shooting time and your total score for the game.

100 is a perfect score. If you shot a man who was surrendering, your total score will be "---".

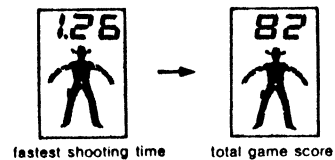

fastest shooting time total game score

GAME - 1 - FAST DRAW

In this game, you will test how fast you can draw and shoot against 6 successive gunmen. The game ends after you have faced the sixth gunman. You will then see the results of the game on the target display — the number of men you shot and your fastest shooting time.

If you shot none of the 6 gunmen, you will score no points. You will see "0" and "999" on the display.

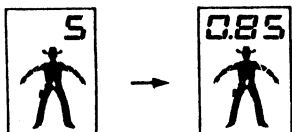

number of gunmen shot fastest shooting time

Game 1 - Display (Skill Level "500")

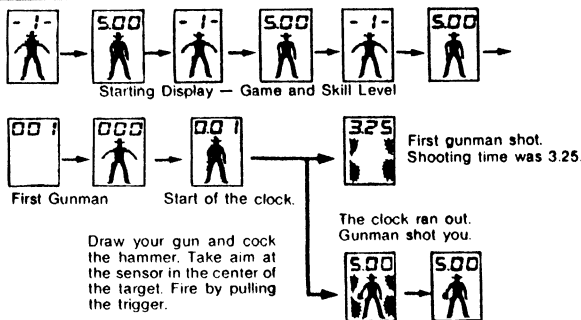

GAME - 2 - SHOWDOWN

In this game, you face a series of gunmen- up to 16, if you play at level "500". Each time you shoot a gunman, the next gunman appears with less time allowed to draw and shoot against him. The progressive speeds for the series are as follows:

5.00 4.00 3.00 2.00 1.80 1.60 1.40 1.20 1.00 0.80 0.60 0.50 0.40

0.30 0.20 0.10 (To play the full series, set the level at 500)

The game ends when you are shot by a gunman or when you have successfully completed the full series. You will then see the results of the game on the target display — your fastest shooting time and the number of gunmen you shot in the series.

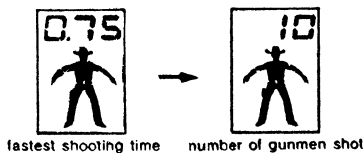

fastest shooting time number of gunmen shot

GAME - 3 - Display (Skill Level "300")

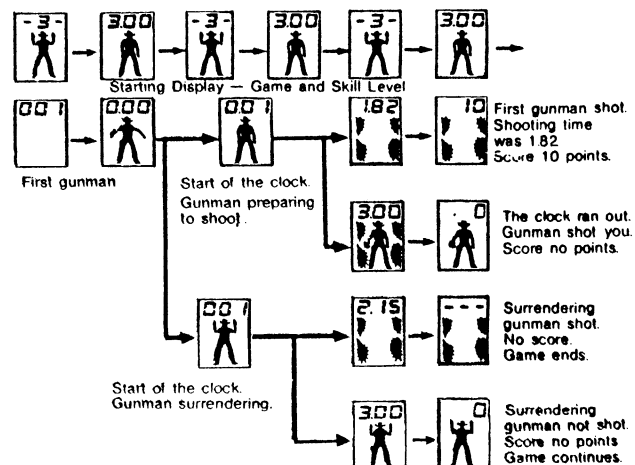

WARNING

Do not leave or play the game in the sun.

Do not hit or drop the target and gun.

They are precision electronic instruments and should not be abused.

The light beam is directed through the muzzle of the gun.

Do not, therefore, aim the gun at someone's eye and do not look into the muzzle.

Do not use or leave the game in places with high humidity or high temperature.

If the target is exposed to much illumination or sun, the sensor will not respond properly to the beam from the gun.

COMPUTER BEAM GUN PROFESSIONAL

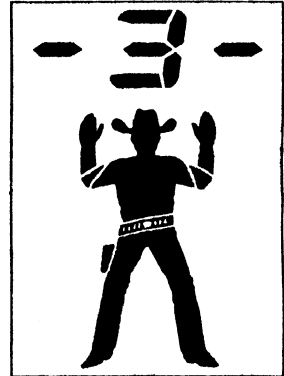
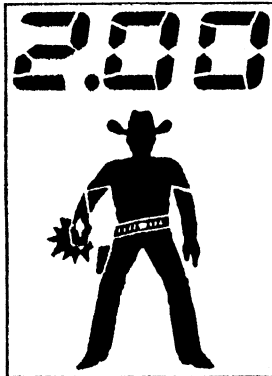
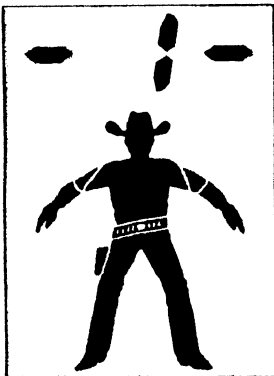

Epoch[®]

Made in Japan. Copyright © 1984. All rights reserved/Epoch Company Ltd., Tokyo, Japan.

www.handheldmuseum.com